

JB SANITARY

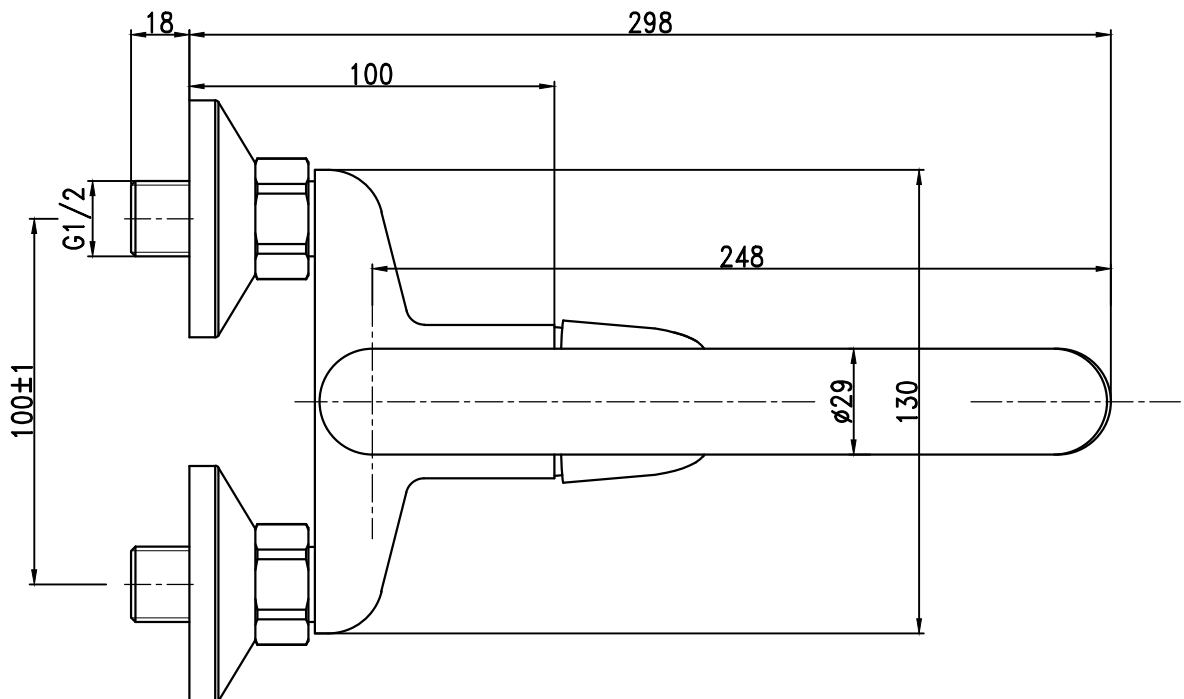
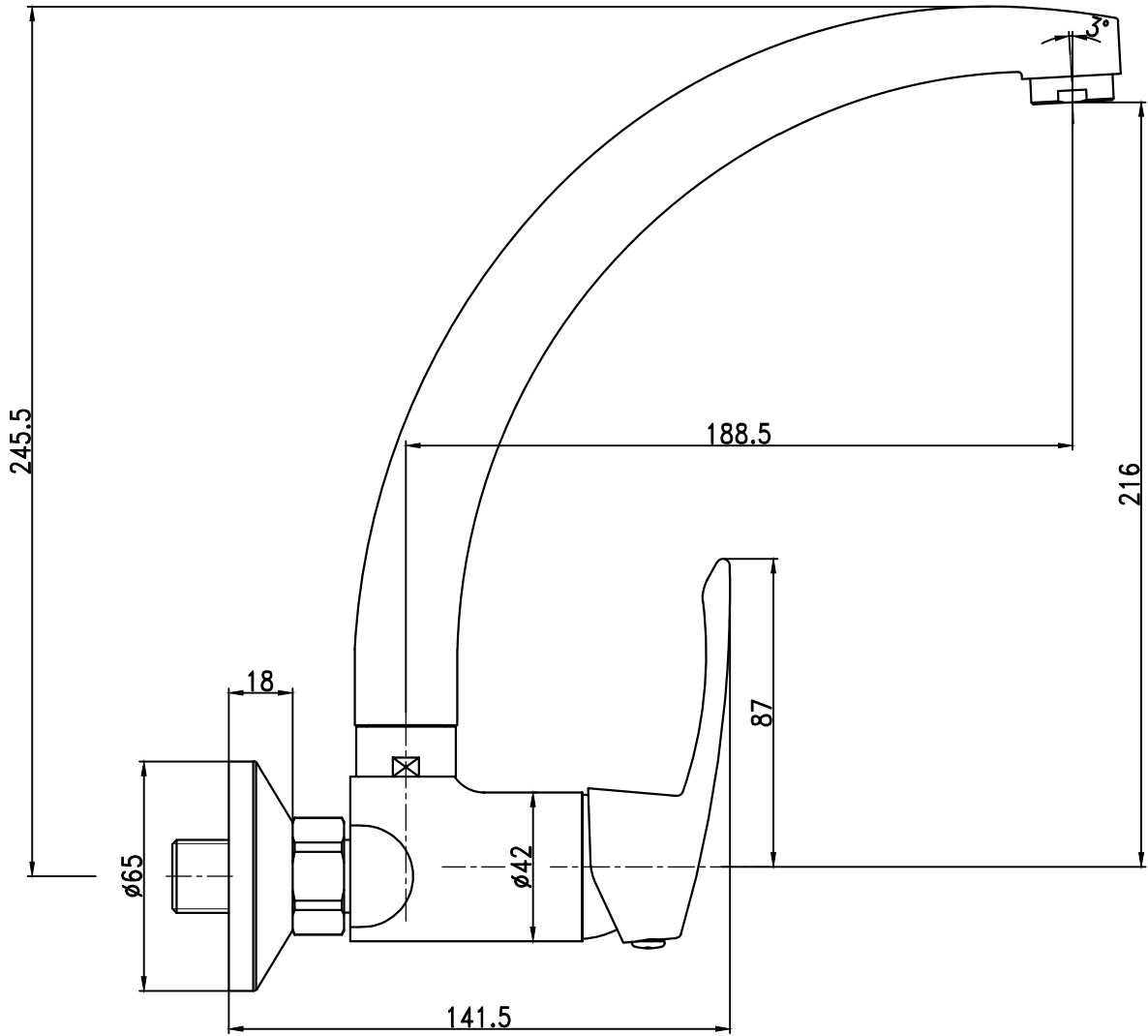

L10 33 80